

Instant Pot®

DUO™ PLUS

Multi-Use Pressure Cooker

Welcome

Initial Set-up

Cooker Parts Overview

Getting Started

Venting Methods

Initial Test Run (Water Test)

More Controls and Smart Programmes

Sous Vide Cooking Steps

Support & Contact Information



Getting Started Guide

Full Manual, How to Videos and Recipes available online at instantpot.co.uk
Register your product today at instantpot.co.uk/support/register



Welcome to the world of Instant cooking.

Hello! Thank you for welcoming us into your kitchen.

Having families ourselves, we developed the Instant Pot® Duo™ Plus to allow busy families and professionals alike to cook healthy, delicious meals more easily and in less time.

We have partnered with chefs, authors and bloggers to compile a collection of recipes that we hope you enjoy!



Robert J. Wang
Founder & Chief Innovation Officer

Download Free App:



Initial Set-up



Initial Set-up

- Read all Important Safeguards in the included Safety, Maintenance & Warranty booklet before use. Failure to do so may result in property damage and/or personal injury.
- Use ONLY the Instant Pot® Duo™ Plus lid with the Instant Pot® Duo™ Plus pressure cooker. Using any other pressure cooker lids may cause injury and/or damage.
- Remove all packaging material from in and around the cooker, and verify that all parts are accounted for.
- Place the cooker on a stable, level surface, away from external heat sources.
- Follow Care & Cleaning instructions in the included Safety, Maintenance & Warranty booklet to wash the cooker before first use.
- Do not remove safety warning stickers from lid, serial number from bottom, or rating label from back of cooker base.



Never use the cooker on a hob. Do not place appliance on or in close proximity to a hot gas or electric burner, or a hot oven. Heat from an external source will damage appliance.

Cooker Parts Overview



Pressure Cook

Soup
Broth

Meat
Stew

Cake

Egg

Slow
Cook

Sauté

Instant Pot[®] Duo Plus

05:20

Less Normal More
Pressure Low High

Pressure Level Keep Warm

— +

Delay Start Cancel

Rice

Bean
Grain

Porridge
Oatmeal

Steam

Sterilize

Yogurt

Sous
Vide



Cooker Parts Overview

Top of Lid

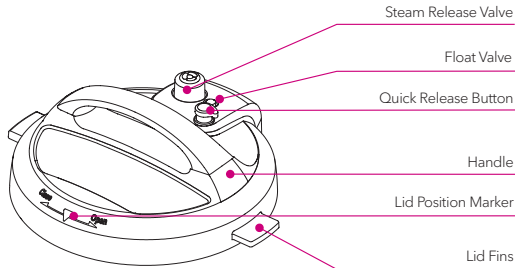

Bottom of Lid

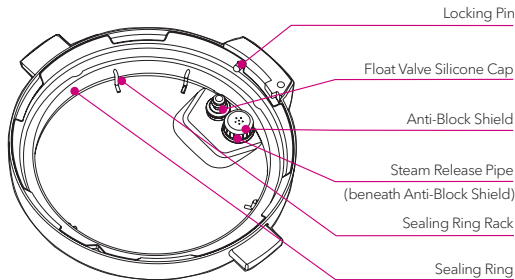

Inner Pot

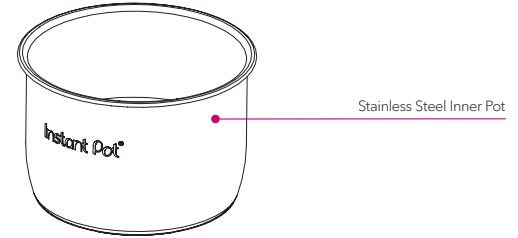

Cooker Base

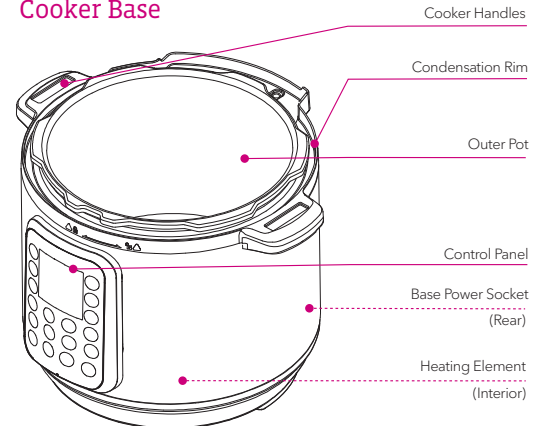

Images are for reference only. Refer to actual product.

A top-down view of a hand pouring white milk from a silver metal can into a rice cooker pot. The pot contains a thick, dark red sauce, green peas, and several slices of orange. The rice cooker has a black exterior and a silver interior. The text "Getting Started" is overlaid in white on the center of the pot.

Getting Started

1

Open & Close Lid

When cooker is plugged in, it will play a jingle when lid is opened and closed.

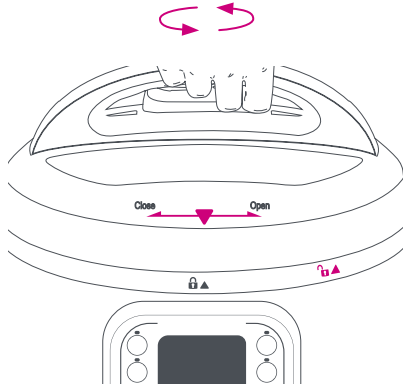

Open

Open: Grip handle and turn lid anti-clockwise until ▼ on lid is aligned with 🔒▲ indicator on the rim of cooker base. Lift lid up and off cooker base.

Note: Always check lid for damage prior to cooking.

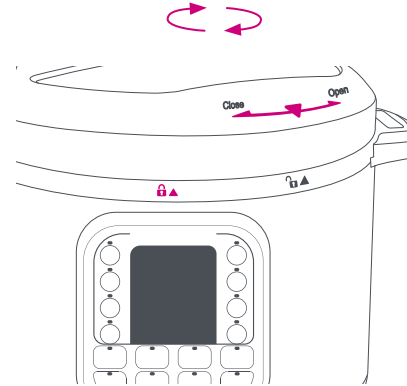

Close

Close: Grip handle and align the ▼ on lid with 🔒▲ indicator on rim of cooker base. Lower lid into track then turn lid clockwise until ▼ on the lid lines up with 🔒▲ indicator on base.

2

Check Sealing Ring & Sealing Ring Rack

Remove: Pull sealing ring out from behind sealing ring rack. Inspect sealing ring rack. It should be centred in the lid and an even height all the way around.

Sealing ring must be installed before use and cleaned after each use.

Install: Place sealing ring over sealing ring rack and press into place. Ensure **entire** sealing ring is snug behind sealing ring rack.

After closing the lid, the sealing ring creates an airtight seal between lid and cooker base. The sealing ring is an integral part of product safety.

Only one sealing ring should be installed when using your cooker.

Replace your sealing ring every 12-18 months or when deformation or damage is noticed.

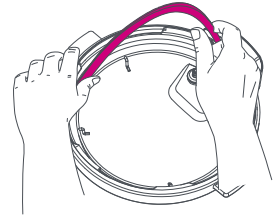

Remove

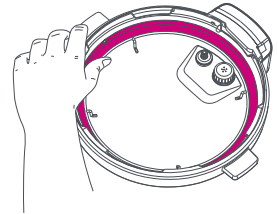

Install

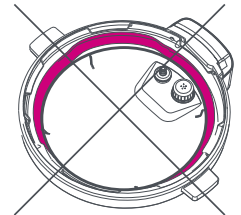

CAUTION

Always check for cuts or deformations in sealing ring prior to cooking. Only use authorised Instant Pot® sealing rings. Failure to follow these instructions may cause food to discharge, which may lead to personal injury or property damage.

CAUTION

Sealing rings may stretch over time. Do not use a stretched or damaged sealing ring. If puckering occurs, replace sealing ring.

3

Remove & Install Float Valve

The float valve has 2 positions. It **pops up** to indicate when the cooker is **pressurised**, and **lowers into the lid** when the cooker is **depressurised**.

Remove: Place one finger on the flat **top** of float valve. Turn lid over. Detach silicone cap from **bottom** side of float valve. Remove float valve from **top** of lid. Do not discard float valve or silicone cap.

The float valve and silicone cap must be installed before use to seal in pressurised steam. Clean after each use.

Install: Drop float valve into float valve hole on top of lid. Place one finger on the flat top of float valve. Turn lid over. Attach silicone cap to bottom of float valve.

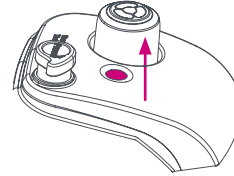

Pressurised

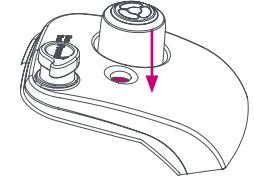

Depressurised

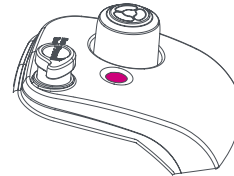

Top

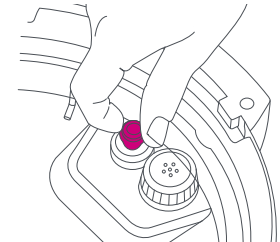

Bottom



WARNING

While float valve is **up**, contents of cooker are pressurised. **Do not attempt to remove lid.** Refer to "Venting Methods" section in this guide for information on releasing pressure. Failure to comply with this instruction could cause injuries or property damage.

4

Remove & Install Anti-Block Shield

Remove: Grip lid and press firmly against side of anti-block shield (pressing towards side of lid and up) until it pops off the prongs underneath.

Anti-block shield must be installed before use and cleaned after each use.

Install: Place anti-block shield over prongs and press down until it snaps into position.

Anti-block shield prevents food particles from coming up through the steam release pipe, assisting with pressure regulation.

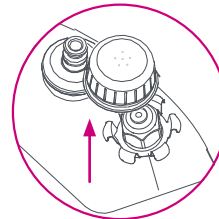
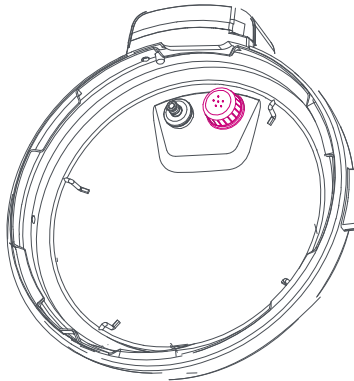

Remove

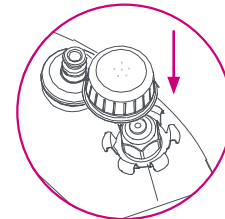

Install

5

Remove & Install Steam Release Assembly

Remove: Pull steam release valve up and off steam release pipe.

Steam release valve must be installed before use and cleaned after each use.

Install: Place steam release valve on steam release pipe and press down.

Fits loosely when installed properly but will remain in place when the lid is turned over.

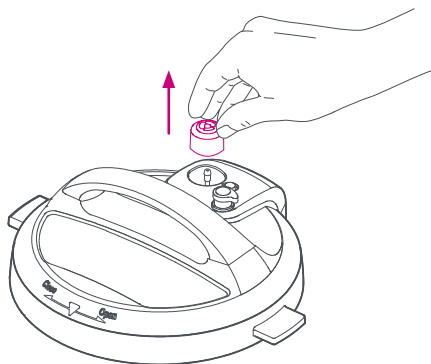

Remove

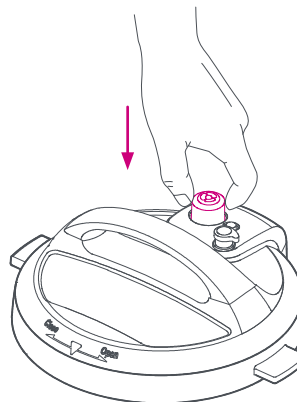

Install

6

Remove & Clean Inner Pot

Remove inner pot from cooker base and wash with hot water and washing up liquid before first use. Wipe outer surfaces of inner pot and heating element to ensure they are dry and free of food debris. Failure to do so may damage the cooker.

Place inner pot into cooker base before cooking. Food must be placed only in the inner pot, not cooker base.

The inner pot is an integral part of product safety. Always use an authorised Instant Pot inner pot made for this model when cooking. Failure to do so may cause personal injury or property damage.

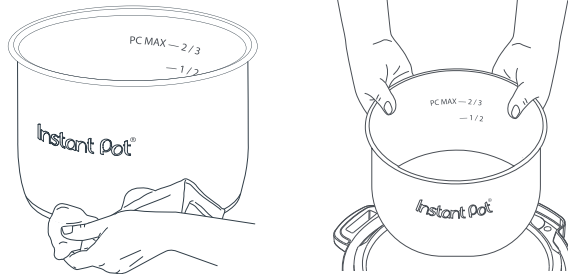

Note: Always check inner pot for dents or deformations prior to cooking.

CAUTION

To avoid risk of personal injury and/or property damage, do not pour food or liquid into cooker base.

WARNING

Do not fill the inner pot higher than the **PC MAX — 2/3 line** (Pressure Cooking Maximum), as indicated on the inner pot. Exercise extreme caution when cooking and venting food such as stewed apples, cranberries, pearl barley, oatmeal, split peas, noodles, etc., as these foods may foam, froth or spatter, and may clog the steam release pipe and/or steam release valve. Do not fill the inner pot higher than the **— 1/2** line when cooking these foods.

7

Install Condensation Collector

Install: On back of cooker base, align grooves on condensation collector over tabs and push condensation collector into place.

The condensation collector accumulates excess water and should be installed before cooking. Clean after use.

Remove: Pull condensation collector away from cooker base. Do not pull down on condensation collector.

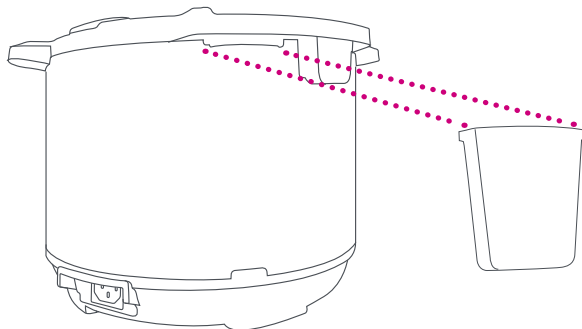

Venting Methods

Venting Methods

When closing the lid, the quick release button will automatically reset to the popped-up “Seal” position.

⚠ WARNING

Do not lean over the steam release valve.

Do not place unprotected skin over the steam release valve.

Do not cover the steam release valve.



Seal



Vent

Natural Release (NR)

Leave the steam release in the “Seal” position (up). The cooker dissipates heat so pressure releases naturally over time. This method must be used when cooking food such as soups, stews or chilis, as well as food that expands, such as beans and grains.

Note: Depressurisation time will vary based upon volume of food and liquid. May take 10-40 minutes, or longer.

Quick Release (QR)

Press quick release button down until it clicks.

When depressed, a continuous stream of steam will be released through the steam release valve until the float valve drops into the lid.

Note: It will be loud!

If spatter occurs, flick quick release button to reset it to the “Seal” position, and try again after a few minutes. If spatter continues, use NR to vent remaining pressure.

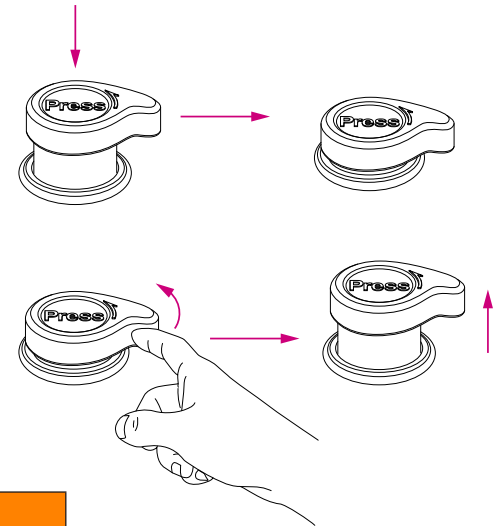

WARNING

The float valve drops when the cooker has depressurised. Do not attempt to open the lid while the float valve is still popped up. Failure to follow these instructions may lead to injury or damage.

A top-down view of a red ceramic bowl filled with a vegetable soup. The soup contains chunks of potatoes, green peas, sliced onions, and carrots in a dark, rich broth. The bowl is placed on a light blue and white checkered napkin, which is set on a dark wooden table. A black lid is partially visible on the left side of the frame. The text "Initial Test Run (Water Test)" is overlaid in the center of the bowl in a white, bold, sans-serif font.

**Initial Test Run
(Water Test)**

Initial Test Run (Water Test)

1. Add 3 cups (750 ml) water to inner pot.
2. Insert inner pot into cooker base.
3. Secure power lead to base power socket.
Ensure connection is tight.
Connect power lead to a 220-240 V power source.
Display indicates "OFF".
4. Align ▼ on lid with ⚡▲ on cooker base.
Lower lid into track, then turn lid clockwise until jingle sounds.
Steam release automatically resets to "Seal" position when the lid is closed.
5. Select Smart Programme: **Pressure Cook**.
6. Use + / - keys to adjust cooking time to "00:05" minutes.
Note: The Instant Pot will save any customisation made to cooking time.
After 10 seconds, display indicates "On" and cooker begins **Pre-heating**.
7. Float valve rises when cooker has pressurised.
Once pressurised, **Cooking** begins and display changes from "On" to cooking time countdown.
8. When the Smart Programme is completed, cooker begins **Keep Warm** or display indicates "End".
9. Press quick release button down until it clicks into "Vent" position.
Pressurised steam will release through top of steam release valve.
Float valve will drop when pressure has been fully released.
10. To open, turn the lid anti-clockwise until a jingle sounds.
11. Discard water and dry inner pot.
12. Start cooking!

For details on Smart Programmes and operating instructions, view the full manual at instantpot.co.uk

A top-down view of a black plate with three seared scallops, asparagus, cherry tomatoes, and herbs on a wooden background. The scallops are arranged in a slight arc, with two on the left and one on the right. They are seared to a golden-brown color. The asparagus is cut into three pieces and lies horizontally across the bottom of the plate. Several cherry tomatoes are scattered around the scallops, some on a small vine with green leaves. Fresh herbs, including a sprig of rosemary and some green onions, are also present. The plate is set on a light-colored wooden surface, and the background is a dark wooden table with some nuts scattered on it.

More Controls & Smart Programmes

More Controls

Cancel	Press to stop a Smart Programme at any time. Cooker goes back to Standby and displays " OFF ".
Delay Start	Postpone cooking up to 24 hours. Select a Smart Programme and, if desired, adjust the cooking time, then press Delay Start to turn the setting on. Use the +/- keys to adjust the number of hours before cooking will begin.
Keep Warm	Setting is on by default on all Smart Programmes except Sauté and Yogurt . Once Smart Programme is selected, press Keep Warm to turn the setting off.
Sound On	When in Standby, press and hold "+" key until display indicates " S On ".
Sound Off	When in Standby, press and hold "-" key until display indicates " S OFF ". <i>Note: Error code alerts cannot be silenced.</i>
Temperature Units: °F to °C	Press both + and - buttons simultaneously and quickly twice. Default temperature unit will be displayed. Press + button repeatedly to toggle between °F and °C. <i>Note: Temperature is only displayed within the Sous Vide Smart Programme.</i>

Smart Programmes

Smart Programme	Setting	Suggested Use	Note:
Soup/Broth	Less	Soup without meat	Liquid remains clear due to lack of boiling motion. Always use NR to release pressure when cooking soup with a high starch content.
	Normal	Soup with meat	
	More	Rich bone broth	
Meat/Stew	Less	Soft texture	Choose setting based on desired meat texture, or adjust cooking time manually. Allow meat to "rest" for 5-30 minutes (depending on size), either in the cooker or covered.
	Normal	Very soft texture	
	More	Fall-off-the-bone texture	
Beans/Grain*	Less	Firmer texture	Choose setting based on desired bean texture, or adjust cooking time manually. When cooking beans or legumes, always use NR to release pressure. Ensure dry beans are completely submerged in water. <i>*5.7 & 8 Litres Only</i>
	Normal	Soft texture	
	More	Very soft texture	
Cake*	Less	Lighter, moist cakes	Adjust cooking time as directed in recipe. <i>*5.7 & 8 Litres Only</i>
	Normal	Denser, moist cakes	
	More	Cheesecakes	
Egg	Less	Soft-boiled eggs	Pre-set times are intended for extra large eggs. Adjust cooking time to account for different sized eggs. Plunge eggs into ice bath to prevent overcooking.
	Normal	Medium-boiled eggs	
	More	Hard-boiled eggs	
Rice	Less	Tender but firm to bite	Depending on the volume of rice, cooking time may range from 8-15 minutes. After cooking, wait 10 minutes then use QR to vent.
	Normal	Normal texture white rice	
	More	Softer texture white rice	
Porridge/ Oatmeal	Less	Oatmeal—coarse or rolled	Adjust time as directed in recipe. Always use NR to release pressure when cooking foods that expand.
	Normal	White rice porridge/congee	
	More	Rice porridge/congee with a mixture of various grains	

Smart Programme	Setting	Suggested Use	Note:
Sterilise	Less	No pressure steam sterilisation	Sterilisation of baby bottles, jars, utensils. Suitable for tempered glass and heat-resistant plastics.
	Normal	Low pressure water-bath preserving of acidic fruits and vegetables.	
	More	High pressure water-bath preserving of acidic fruits and vegetables.	
Steam	Less	Vegetables	Use steam rack provided to elevate food from cooking liquid. Use QR to prevent food from overcooking.
	Normal	Fish and seafood	
	More	Meat	
Sous Vide	77-194°F 25-90°C	Cook eggs, fruit, vegetables, fish, poultry, pork, beef and lamb	We recommend salting lightly and adding seasoning to taste after cooking. Use garlic powder rather than raw garlic. If your dish is not going to be consumed immediately, plunge pouches into iced water to reduce temperature quickly, then keep refrigerated.
Pressure Cook	Less	Manual programming	Press Pressure Level to toggle between High and Low pressure. Use + / - keys to adjust cooking time. Adjust according to recipe for desired results.
	Normal		
	More		
Slow Cook	Less	Less corresponds to Low on standard slow cookers.	Ensure quick release button is set to " Vent " position. Alternatively, use a glass lid for slow cooking.
	Normal	Normal corresponds to Medium on standard slow cookers.	
	More	More corresponds to High on standard slow cookers.	
Sauté	Less	Simmering & reducing	Do not use the lid on Sauté. Maximum 30 minutes to prevent overheating. When display switches from " On " to " Hot ", add recipe ingredients. If ingredients are added before " Hot " message appears, it may not appear at all.
	Normal	Pan searing or sautéing	
	More	Stir-frying or browning meat	
Yogurt	Less	Low-temperature fermentation (Jiu Niang)	Milk must reach a minimum of 72°C (161°F) for pasteurisation to occur. Allow pasteurised milk to cool to below 43°C (110°F). 8 hours is standard for fermentation, but a longer period will result in tangier yogurt.
	Normal	Fermenting yogurt	
	More	Pasteurising milk	

Pressure cooking Smart Programmes operate at **High** (70 - 80 kPa) or **Low** (40 - 50 kPa) pressure. Higher pressure results in higher temperature.



Sous Vide Cooking Steps

Sous Vide Cooking Steps

1. Place a steam rack on bottom of inner pot.
2. Fill inner pot with warm water up to **PC MAX – 2/3** line.
3. Insert inner pot into cooker base.
4. Secure power lead to base power socket. Ensure connection is tight. Connect to a 220-240 V power source.
5. Place lid on cooker base and turn lid clockwise to close.
6. Select **Sous Vide**.
7. Use **+ / -** keys to adjust temperature in increments of 1°C / 1°F.
8. Press **Sous Vide** again to toggle to cooking time setting.
9. Use **+ / -** keys to adjust cooking time. After 10 seconds, cooker beeps 3 times and displays **"On"** to indicate that it has begun heating.
10. While cooker heats, season food as desired. Separate single servings of food within individual pouches. Remove air from pouches and seal tightly.
11. Cooker beeps once water temperature is reached. Remove lid and immerse sealed pouches in water. Contents should be submerged, but seal should remain above water.
12. Place lid on cooker base and turn lid clockwise to close.
13. For long cooking times, ensure water level remains above sealed pouches.
Note: If you need to add water, heat it to approximately the same temperature as the water in the inner pot to avoid cooling.
14. Once complete, display indicates **"End"**.
Open cooker and carefully remove pouches from water.
15. Remove contents from pouches and use a thermometer to check they are done.
Follow a recipe or **"Sous Vide Cooking Guidelines"** online.
*Bonus: "Reverse searing" your meat (searing it after cooking, not before) is a great way to boost flavour. First pat the meat dry, then sear it lightly in the inner pot using **Sauté**.*

Enjoy time well spent with the Instant family of small appliances.

Instant Pot®

Instant Brands Inc.
11-300 Earl Grey Dr., Suite 383
Ottawa, Ontario
K2T 1C1
Canada

Earlyview Ltd (Instant Pot Official Distributor)
5 Hershaw Farm Business Park
Kitsmead Lane,
Chertsey
Surrey, KT16 0DN
UK.

instantpot.co.uk
instantpot.co.uk/instant-pot-shop

Made in China



Copyright © 2019 Instant Brands™ Inc

Register your product today at:
instantpot.co.uk/support/register
Contact Customer Care:
+44 (0) 3331 230051
support@instantpot.co.uk

Join the Official Instant Pot® Community:
[www.facebook.com/groups/
InstantPotUKCommunity](https://www.facebook.com/groups/InstantPotUKCommunity)

Download Free App:



 @instantpotUK
 @InstantPotUK
 @instantpotuk

629-0304-02